



**Technical and Test Institute
for Construction Prague**

Prosecká 811/76a
190 00 Prague
Czech Republic
eota@tzus.cz



Member of



www.eota.eu

European Technical Assessment

ETA 16/0841 of 20/05/2018

Technical Assessment Body issuing the ETA: Technical and Test Institute
for Construction Prague

Trade name of the construction product

MO-H,
MO-HW,
MO-HS
steel bonded anchor

**Product family to which the
construction product belongs**

Product area code: 33
Injection anchors for use in masonry

Manufacturer

Index Técnicas Expansivas, S.L.
P.I. La Portalada II C. Segador 13
26006 Logroño
Spain

Manufacturing plant(s)

Index Plant 1

**This European Technical Assessment
contains**

15 pages including 11 Annexes which form
an integral part of this assessment.

**This European Technical Assessment is
issued in accordance with regulation
(EU) No 305/2011, on the basis of**

EAD 330076-00-0604

This version replaces

ETA 16/0841 issued on 31/10/2016

Translations of this European Technical Assessment in other languages shall fully correspond to the original issued document and should be identified as such.

Communication of this European Technical Assessment, including transmission by electronic means, shall be in full (excepted the confidential Annex(es) referred to above). However, partial reproduction may be made, with the written consent of the issuing Technical Assessment Body. Any partial reproduction has to be identified as such.

1. Technical description of the product

The MO-H, MO-HW (faster curing time) and MO-HS (extended curing time) for masonry is a bonded anchor consisting of a cartridge with injection mortar, a plastic sieve sleeve and an anchor rod with a hexagon nut and a washer. The steel elements are made of galvanized steel or stainless steel.

The sieve sleeve is pushed into a drilled hole and filled with injection mortar before the anchor rod is placed in the sieve sleeve. The steel element is anchored via the bond between metal part, injection mortar and masonry.

The illustration and the description of the product are given in Annex A.

2. Specification of the intended use in accordance with the applicable EAD

The performances given in Section 3 are only valid if the anchor is used in compliance with the specifications and conditions given in Annex B.

The provisions made in this European Technical Assessment are based on an assumed working life of the anchor of 50 years. The indications given on the working life cannot be interpreted as a guarantee given by the producer, but are to be regarded only as a means for choosing the products in relation to the expected economically reasonable working life of the works.

3. Performance of the product and references to the methods used for its assessment

3.1 Mechanical resistance and stability (BWR 1)

Essential characteristic	Performance
Characteristic resistance for tension and shear loads	See Annex C 1
Reduction factor for job site tests (β – factor)	See Annex C 1
Edge distances and spacing	See Annex B 5
Displacement under shear and tension loads	See Annex C 1
Durability	See Annex A 3

3.2 Safety in case of fire (BWR 2)

Essential characteristic	Performance
Reaction to fire	Anchorage satisfies requirements for Class A1

3.3 Hygiene, health and environment (BWR 3)

No performance determined.

3.4 General aspects relating to fitness for use

Durability and serviceability are only ensured if the specifications of intended use according to Annex B 1 are kept.

4. Assessment and verification of constancy of performance (AVCP) system applied with reference to its legal base

According to the Decision 97/177/EC of the European Commission¹, the system of assessment and verification of constancy of performance (see Annex V to Regulation (EU) No 305/2011) given in the following table applies.

Product	Intended use	Level or class	System
Injection anchors for use in masonry	For fixing and/or supporting to masonry, structural elements (which contributes to the stability of the works) or heavy units	-	1

¹ Official Journal of the European Communities L 073 of 14.03.1997

5. Technical details necessary for the implementation of the AVCP system, as provided in the applicable EAD

5.1 Tasks of the manufacturer

The manufacturer may only use raw materials stated in the technical documentation of this European Technical Assessment.

The factory production control shall be in accordance with the control plan which is a part of the technical documentation of this European Technical Assessment. The control plan is laid down in the context of the factory production control system operated by the manufacturer and deposited at Technical and Test Institute for Construction Prague². The results of the factory production control shall be recorded and evaluated in accordance with the provisions of the control plan.

5.2 Tasks of the notified bodies

The notified body shall retain the essential points of its actions referred to above and state the results obtained and conclusions drawn in a written report.

The notified certification body involved by the manufacturer shall issue a certificate of constancy of performance of the product stating the conformity with the provisions of this European Technical Assessment.

In cases where the provisions of the European Technical Assessment and its control plan are no longer fulfilled, the notified body shall withdraw the certificate of constancy of performance and inform Technical and Test Institute for Construction Prague without delay.

Issued in Prague on 20.05.2018

By

Ing. Mária Schaan
Head of the TAB

² The control plan is a confidential part of the documentation of the European technical assessment, but not published together with the ETA and only handed over to the approved body involved in the procedure of AVCP.

Installation in hollow or perforated brick masonry

Installation of anchor rod with sieve sleeve

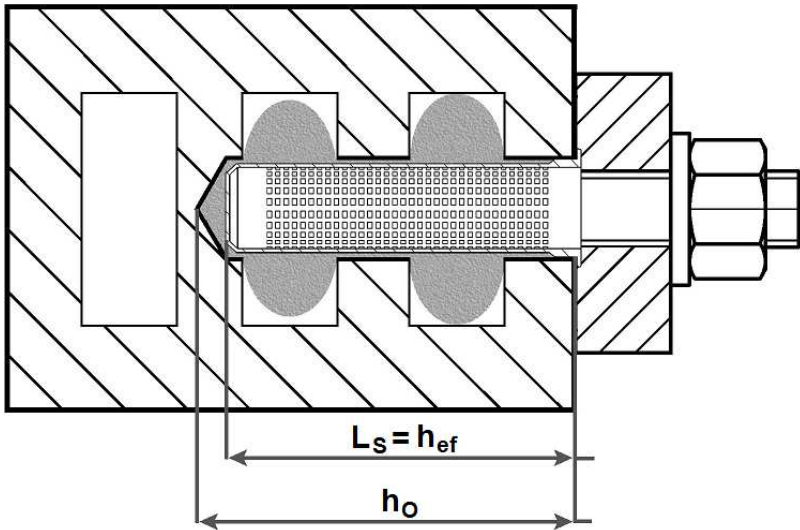

L_s = length of the sieve sleeve

h_{ef} = effective setting depth

h_0 = bore hole depth

**MO-H, MO-HW, MO-HS steel bonded anchor
for masonry**

Product description
Installed condition

Annex A 1

Coaxial cartridge (CC)

MO-H, MO-HW, MO-HS

150 ml
380 ml
400 ml
410 ml



Side by side cartridge (SBS)

MO-H, MO-HW, MO-HS

350 ml
825 ml

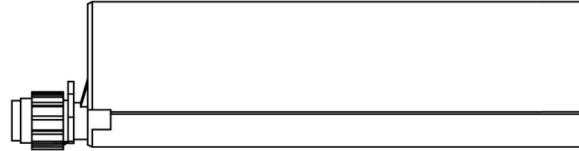

Two part foil in a single piston component cartridge (FCC)

MO-H, MO-HW, MO-HS

150 ml
170 ml
300 ml
550 ml
850 ml



Peeler cartridge (PLR)

MO-H, MO-HW, MO-HS

280 ml



Marking of the mortar cartridges

Identifying mark of the producer, Trade name, Charge code number, Storage life, Curing and processing time

Mixing nozzle

KW



RC

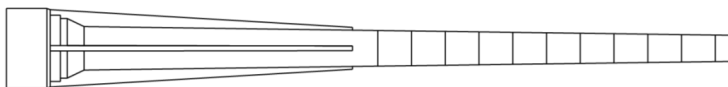

RM

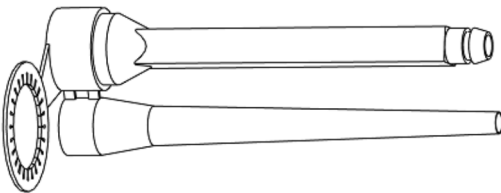

TB

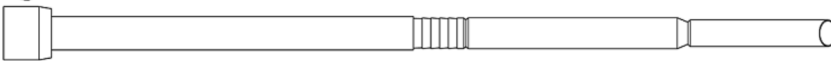

KR for use with 850

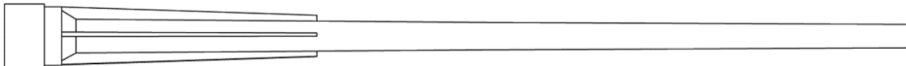

MO-H, MO-HW, MO-HS steel bonded anchor for masonry

Product description
Injection system

Annex A 2

Threaded rod M8, M10, M12

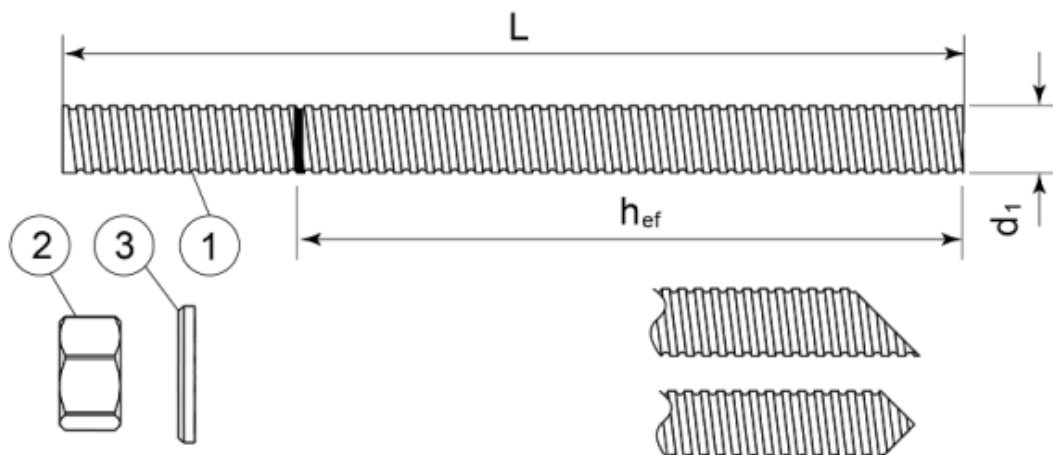

Standard commercial threaded rod with marked embedment depth

Part	Designation	Material
Steel, zinc plated $\geq 5 \mu\text{m}$ acc. to EN ISO 4042 or Steel, Hot-dip galvanized $\geq 40 \mu\text{m}$ acc. to EN ISO 1461 and EN ISO 10684 or Steel, zinc diffusion coating $\geq 15 \mu\text{m}$ acc. to EN 13811		
1	Anchor rod	Steel, EN 10087 or EN 10263 Property class 5.8, 8.8, 10.9* EN ISO 898-1
2	Hexagon nut EN ISO 4032	According to threaded rod, EN 20898-2
3	Washer EN ISO 887, EN ISO 7089, EN ISO 7093 or EN ISO 7094	According to threaded rod
Stainless steel		
1	Anchor rod	Material: A2-70, A4-70, A4-80, EN ISO 3506
2	Hexagon nut EN ISO 4032	According to threaded rod
3	Washer EN ISO 887, EN ISO 7089, EN ISO 7093 or EN ISO 7094	According to threaded rod
High corrosion resistant steel		
1	Anchor rod	Material: 1.4529, 1.4565, EN 10088-1
2	Hexagon nut EN ISO 4032	According to threaded rod
3	Washer EN ISO 887, EN ISO 7089, EN ISO 7093 or EN ISO 7094	According to threaded rod

*Galvanized rod of high strength are sensitive to hydrogen induced brittle failure

**MO-H, MO-HW, MO-HS steel bonded anchor
for masonry**

Product description
Threaded rod and materials

Annex A 3

Sieve sleeve

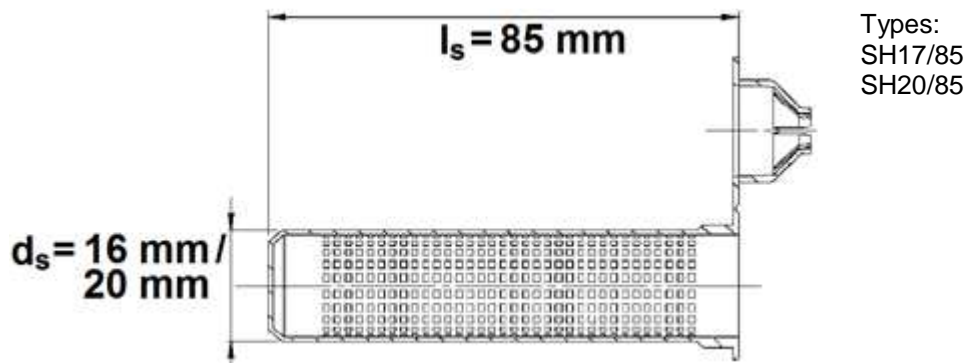

Designation	Material
Sieve sleeve	Polypropylene

MO-H, MO-HW, MO-HS steel bonded anchor for masonry

Product description
Sleeve

Annex A 4

Specifications of intended use

Anchorage subject to:

- Static and quasi-static loads

Base materials

- Hollow brick masonry (Masonry group c), according to Annex B2.
- Mortar strength class of the masonry M2,5 at minimum according to EN 998-2:2010.
- For other bricks in hollow or perforated masonry, the characteristic resistance of the anchor may be determined by job site tests according to EOTA Technical Report TR 053 under consideration of the β -factor to Annex C1, Table C4.

Temperature range:

- T_b : -40°C to +80°C (max. short. term temperature +80°C and max. long term temperature +50°C)

Use conditions (Environmental conditions)

- (X1) Structures subject to dry internal conditions (zinc coated steel)

Use conditions in respect of installation and use:

- Category d/d - Installation and use in structures subject to dry, internal conditions
- Category w/d - Installation in dry or wet substrate and use in structures subject to dry, internal conditions

Design:

- Verifiable calculation notes and drawings are prepared taking account the relevant masonry in the region of the anchorage, the loads to be transmitted and their transmission to the supports of the structure. The position of the anchor is indicated on the design drawings.
- The anchorage are designed in accordance with the EOTA Technical Report TR 054, Design method A, under the responsibility of an engineer experienced in anchorages and masonry work.

Installation:

- Dry or wet structures
- Anchor Installation carried out by appropriately qualified personnel and under the supervision of the person responsible for technical matters of the site.

**MO-H, MO-HW, MO-HS steel bonded anchor
for masonry**

**Intended use
Specifications**

Annex B 1

Table B1: Types and dimensions of block and bricks

Brick N° 1

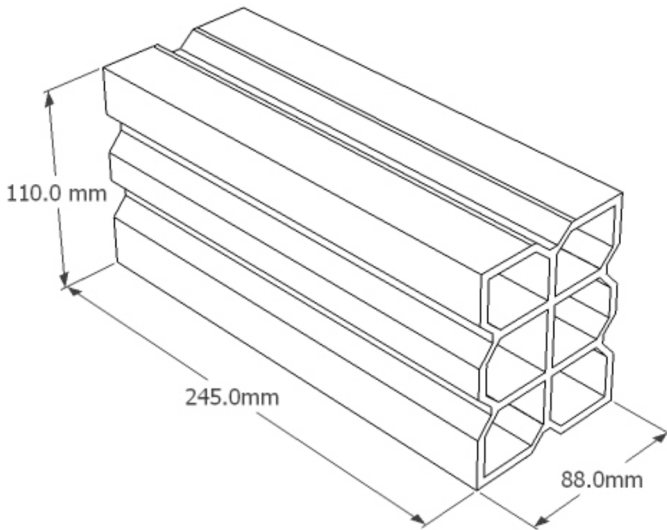

Hollow clay brick Hueco Doble
 according to EN 771-1
 length/width/height = 245 mm/110 mm/88 mm
 $f_b \geq 2,5 \text{ N/mm}^2$ / $\rho \geq 0,74 \text{ kg/dm}^3$

Brick N° 2

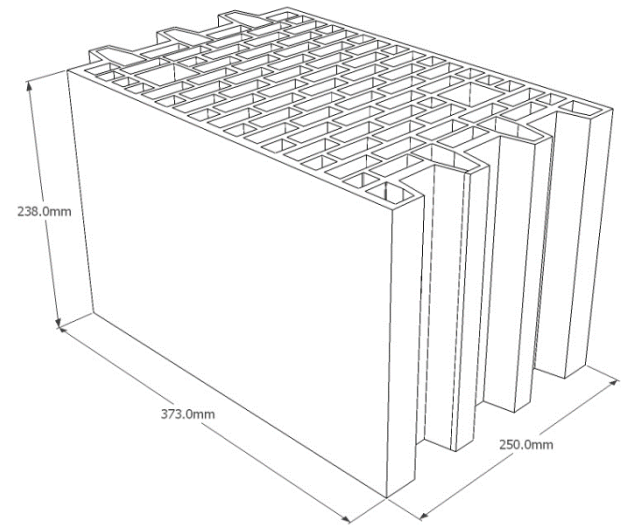

Hollow clay brick Porotherm P+W
 according to EN 771-1
 length/width/height = 373 mm/250 mm/238 mm
 $f_b \geq 12 \text{ N/mm}^2$ / $\rho \geq 0,9 \text{ kg/dm}^3$

**MO-H, MO-HW, MO-HS steel bonded anchor
 for masonry**

Intended use
 Brick types and properties

Annex B 2

Applicator gun

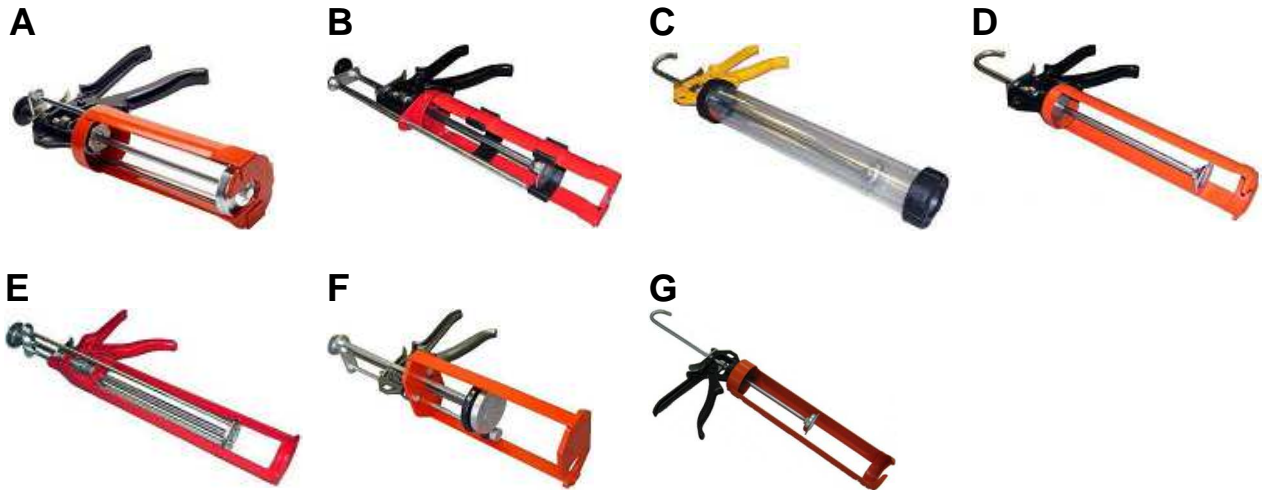

Applicator gun	A	B	C	D	E	F	G
Cartridge	Coaxial 380ml 400ml 410ml	Side by side 350ml	Foil capsule 150ml 300ml 550ml	Foil capsule 150ml 300ml Peeler 280ml	Coaxial 150ml	Side by side 825ml	Foil capsule 850ml

Cleaning brush

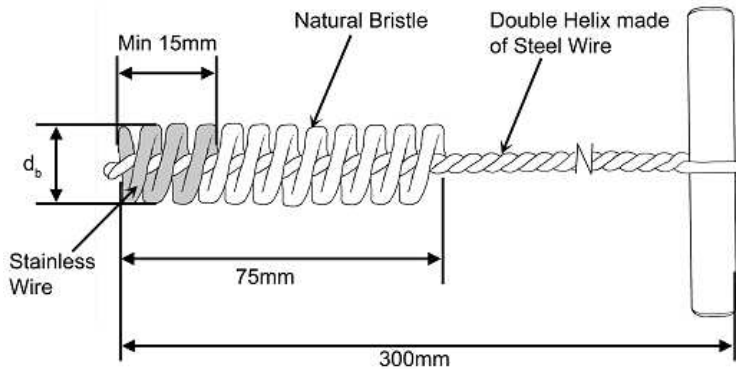

Cleaning pump

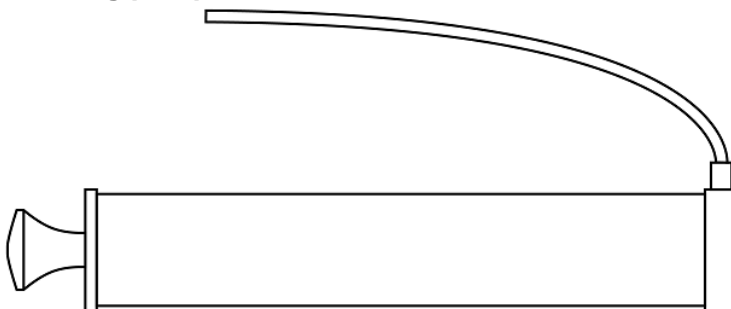







MO-H, MO-HW, MO-HS steel bonded anchor for masonry

Intended use
 Applicator guns
 Cleaning brush, Cleaning pump

Annex B 3

Installation instructions

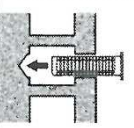
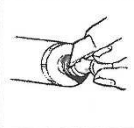
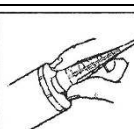
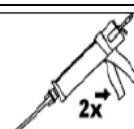
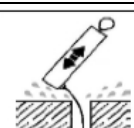
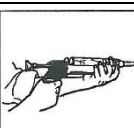
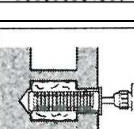
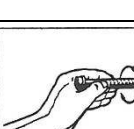
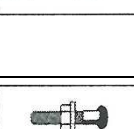
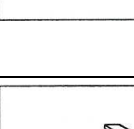
	<p>1. Drill the hole to the correct diameter and depth using a rotary percussive machine.</p>		<p>2. Use the cleaning pump to clean the hole.</p>
	<p>3. Use the cleaning brush to clean the hole. Diameter of cleaning brush according to Table B2.</p>		<p>4. Use the cleaning pump to clean the hole.</p>
	<p>5. Use the cleaning brush to clean the hole. Diameter of cleaning brush according to Table B2.</p>		<p>6. Use the cleaning pump to clean the hole.</p>
	<p>7. If use in hollow or perforated brick masonry: Plug the centering cap and insert the correct perforated sleeve flush with the surface of the base material.</p>		<p>8. Once the hole is prepared remove the screw cap from the cartridge.</p>
	<p>9. Attach the mixer nozzle and place the cartridge in the applicator gun.</p>		<p>10. Dispense the first part to waste, until an even colour is achieved.</p>
	<p>11. Remove any free water from the hole.</p>		<p>12. Insert the nozzle to the far end of the hole (using extension tubing if necessary) and inject the resin, withdrawing the nozzle/tube as the hole fills.</p>
	<p>13. If use in hollow or perforated brick masonry: Insert mixer nozzle to the end of the perforated sleeve and completely fill the sleeve with resin. Withdraw the mixer nozzle as the sleeve fills.</p>		<p>14. Immediately insert the fixing (steel element) slowly and with a slight twisting motion. Remove excess resin from around the mouth of the hole.</p>
	<p>15. Leave the fixing undisturbed until the cure time (see Table B4) has elapsed.</p>		<p>16. Attach the fixture and tighten the nut. Maximum installation torque moment according to Table B2.</p>

MO-H, MO-HW, MO-HS steel bonded anchor for masonry

Intended use
Installation instructions

Annex B 4

Table B2: Installation parameters in hollow masonry

Anchor type		Anchor rod		
Size		M8	M10	M12
Sieve sleeve	l_s [mm]	85	85	85
	d_s [mm]	16	16	20
Nominal drill hole diameter	d_0 [mm]	16	16	20
Diameter of cleaning brush	d_b [mm]	20 \pm 1	20 \pm 1	22 \pm 1
Depth of the drill hole	h_0 [mm]	90		
Effective anchorage depth	h_{ef} [mm]	85		
Diameter of clearance hole in the fixture	$d_f \leq$ [mm]	9	12	14
Torque moment	$T_{inst} \leq$ [Nm]	2		

Table B3: Edge distances and spacing

Base material ¹⁾	Anchor rod					
	M8, M10			M12		
	$c_{cr} = c_{min}$	$s_{cr } = s_{min }$	$s_{cr\perp} = s_{min\perp}$	c_{cr}	$s_{cr } = s_{min }$	$s_{cr\perp} = s_{min\perp}$
	[mm]	[mm]	[mm]	[mm]	[mm]	[mm]
Brick N° 1	100	245	110	120	245	110
Brick N° 2	100	373	238	120	373	238

¹⁾ Brick N° according to Annex B 2

MO-H, MO-HW, MO-HS steel bonded anchor for masonry

Intended use
Installation parameters

Annex B 5

Table B4.1: Minimum curing time MO-H

Base material Temperature [°C]	T Work [mins]	T Load [mins]
+5 to +10	10	145
+10 to +15	8	85
+15 to +20	6	75
+20 to +25	5	50
+25 to +30	4	40

T Work refers to the highest temperature in the range.
T Load time refers to the lowest temperature in the range.
Cartridge must be conditioned to a minimum +5°C.

Table B4.2: Minimum curing time MO-HW

Base material Temperature [°C]	T Work [mins]	T Load [mins]
0 to +5	10	75
+5 to +20	5	50
+20	100 second	20

T Work refers to the highest temperature in the range.
T Load time refers to the lowest temperature in the range.
Cartridge must be conditioned to a minimum 0°C.

Table B4.3: Minimum curing time MO-HS

Base material Temperature [°C]	T Work [mins]	T Load [mins]
+15 to +20	15	5
+20 to +25	10	145
+25 to +30	7.5	85
+30 to +35	5	50
+35 to +40	3.5	40

T Work refers to the highest temperature in the range.
T Load time refers to the lowest temperature in the range.
Cartridge must be conditioned to a minimum +15°C.

**MO-H, MO-HW, MO-HS steel bonded anchor
for masonry**

Intended use
Working and curing time

Annex B 6

Table C1: Characteristic resistance under tension and shear loading

Base material	Anchor rods $N_{Rk} = V_{Rk}$ [kN] ¹⁾			Partial safety factor γ_{Mm} ²⁾ [-]		
	M8	M10	M12	M8	M10	M12
Brick N° 1	0,9	1,5	1,5	2,5		
Brick N° 2	2,0	2,0	2,5			

¹⁾ For design according TR 054: $N_{Rk} = N_{Rk,p} = N_{Rk,b} = N_{Rk,s}$; $N_{Rk,pb}$ according to TR 054

For $V_{Rk,s}$ see Annex C1, Table C2; Calculation of $V_{Rk,pb}$ and $V_{Rk,c}$ according to TR 054

²⁾ In the absence of other national regulations

Table C2: Characteristic bending moment

Size		M8	M10	M12
Steel grade 5.8	$M_{Rk,s}$ [N.m]	19	37	66
Partial safety factor	γ_{Ms} ¹⁾ [-]	1,25		
Steel grade 8.8	$M_{Rk,s}$ [N.m]	30	60	105
Partial safety factor	γ_{Ms} ¹⁾ [-]	1,25		
Steel grade 10.9	$M_{Rk,s}$ [N.m]	37	75	131
Partial safety factor	γ_{Ms} ¹⁾ [-]	1,50		
Stainless steel grade A2-70, A4-70	$M_{Rk,s}$ [N.m]	26	52	92
Partial safety factor	γ_{Ms} ¹⁾ [-]	1,56		
Stainless steel grade A4-80	$M_{Rk,s}$ [N.m]	30	60	105
Partial safety factor	γ_{Ms} ¹⁾ [-]	1,33		
Stainless steel grade 1.4529 strength class 70	$M_{Rk,s}$ [N.m]	26	52	92
Partial safety factor	γ_{Ms} ¹⁾ [-]	1,25		
Stainless steel grade 1.4565 strength class 70	$M_{Rk,s}$ [N.m]	26	52	92
Partial safety factor	γ_{Ms} ¹⁾ [-]	1,56		

¹⁾ In the absence of other national regulations

Table C3: Displacements under tension and shear load

Base material	F [kN]	δ_{N0} [mm]	$\delta_{N\infty}$ [mm]	δ_{v0} [mm]	$\delta_{v\infty}$ [mm]
Hollow clay brick	$N_{Rk} / (1,4 \cdot \gamma_M)$	0,5	1,0	1,0 ¹⁾	1,5 ¹⁾

¹⁾ the hole gap between bolt and fixture shall be considered additionally

Table C4: β - factors for job site tests according to TR 053

Brick N°	N° 1	N° 2
β - factor	0,78	0,83

MO-H, MO-HW, MO-HS steel bonded anchor for masonry

Performances

Characteristic resistance, displacement
 β -factors for job site testing under tension load

Annex C 1