



**CARACTERISTICAS**

- Bridas dentadas de nailon para cables fabricadas con poliamida 6,6 no propagadoras de incendios y diseñadas para la fijación de conjuntos de cables, enchufes, tuberías y embalajes.
- Accesorios disponibles: bridas para cables de identificación, bases adhesivas bilaterales, placas de identificación.
- Bridas para cables detectables: compatibles con los procesos de calidad de aquellas instalaciones en las que se fabriquen productos alimentarios en conformidad con los requisitos de la metodología HACCP (Análisis de Peligros y Puntos Críticos de Control).
- En blanco, en negro o de colores
- Bridas para cables de nailon en color negro fabricadas con poliamida y carbono negro: para uso externo (una mayor resistencia a la radiación ultravioleta).
- Alta resistencia a los alcalinos, a los aceites, a las grasas, a los derivados del petróleo y a los disolventes clorados.
- Resistencia limitada a los ácidos.
- Sin resistencia a los ácidos de alquitrán.
- Sin halógenos.
- No propagadoras de incendios
- Conformes con la norma UNE-EN IEC 62275.
- Bridas para cables aprobadas por UL en conformidad con la norma UL 62275, tipo 21
- Los modelos BN-N y BN-B cuentan con el sello de la CE en conformidad con la directiva 2014/35/UE
- Cumple con las normativas RoHS, PAH y REACH.



**PAHs RoHS**

**MATERIAL BASE**































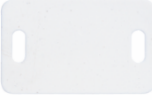

BN-N/B/VE/MA/AM/ AZ/RO/PL/ID

TACOBRI B/N/GR

BN-BA

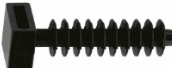

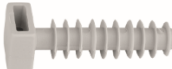
## 1. GAMA

ITEM	CÓDIGO	MEDIDAS	FOTO	COLOR	MATERIAL	CERTIFICADO
1	BN-N	De 2,5 x 80 hasta 12,5 x 1000 mm		NEGRO		 PAHs RoHS
2	BN-B	De 2,5 x 80 hasta 12,5 x 1000 mm		BLANCO		 PAHs RoHS
3	BN-VE	De 2,5 x 100 hasta 4,8 x 290 mm		VERDE		--
4	BN-MA	De 2,5 x 100 hasta 4,8 x 290 mm		MARRON		--
5	BN-AM	De 2,5 x 100 hasta 4,8 x 290 mm		AMARILO		--
6	BN-AZ	De 2,5 x 100 hasta 4,8 x 290 mm		AZUL		--
7	BN-RO	De 2,5 x 100 hasta 4,8 x 290 mm		ROJO		--
8	BN-GR	De 2,5 x 100 hasta 4,8 x 290 mm		GRIS (RAL7035)		--
9	BN-DT	De 2,5 x 100 hasta 7,6 x 370 mm		AZUL		--
10	BN-ID	De 2,5 x 110 hasta 2,5 x 210 mm		BLANCO		--
11	BN-BA	De 19 x 19 hasta 27 x 27 mm		BLANCO / NEGRO		--
12	BN-PL	26,4 x 16,2 mm		BLANCO		--
13	TACOBRI B	De Ø6 hasta Ø8 mm		BLANCO		--
14	TACOBRI N	De Ø6 hasta Ø8 mm		NEGRO		--
15	TACOBRI GR	De Ø6 hasta Ø8 mm		GRIS (RAL7035)		--

## 2. TITULAR DEL DOCUMENTO

Técnicas Expansivas S.L.  
 Segador 13  
 26006 Logroño. España  
[www.indexfix.com](http://www.indexfix.com)  
[info@indexfix.com](mailto:info@indexfix.com)

## 3. CONDICIONES DE TRANSPORTE Y ALMACENAMIENTO

Las bridas para cables deben transportarse en un embalaje completamente cerrado y deben almacenarse a temperatura ambiente protegidas de la luz solar directa.

## 4. INSTRUCCIONES DE INSTALACIÓN

A fin de realizar un uso adecuado, las bridas para cables deberán colocarse y ajustarse únicamente a mano. Consulte a un especialista antes de usar una herramienta de cierre.

## 5. PROPIEDADES DE LAS MATERIAS PRIMAS

Tipo	Tipo 1: retiene por lo menos el 50 % de la fuerza de tensión declarada para el bucle después de las condiciones de prueba
Absorción de la humedad:	2,5 % (23 °C, 50 % HR)
Temperatura operativa	-40 °C hasta +85 °C
Temperatura de instalación	-20 °C hasta +85 °C (-10 °C hasta +85 °C para el tamaño 12,5)
Temperatura permisible máxima	+110 °C, corto plazo
Temperatura de fusión	+260 °C
Índice de oxígeno límite (LOI)	27 %
Cociente de inflamabilidad	UL94 clase V2
Propagación de incendios	No propagadoras de incendios
Resistencia dieléctrica	50 000 voltios/mm
Resina sin halógenos	Sí
Resistencia a la radiación UV	Bridas blancas: no Bridas negras: sí

### Ejemplos de aplicación



## 2. DATOS DE INSTALACIÓN

### 2.1 BN-N/BN-B

Bridas de nylon blancas y negras



#### Características



PAHs RoHS

Poliamida 6.6

Marcado CE y Certificado UL

#### Datos de Instalación

CODIGO		A: Ancho [mm]	B: Largo [mm]	Rango de diámetros (mm)	Resistencia a la tracción $\geq$ [N]
BRIDA BLANCA	BRIDA NEGRA				
BB25080	BN25080	2,5	80	3 ÷ 14	79
BB25100	BN25100		100	3 ÷ 20,5	
BB25140	BN25140		140	3 ÷ 33	
BB25160	BN25160		160	3 ÷ 39,8	
BB25200	BN25200		200	3 ÷ 52,5	
BB36140	BN36140	3,6	140	3,5 ÷ 33	178
BB36200	BN36200		200	3,5 ÷ 46	
BB36250*	BN36250*		250	3,5 ÷ 65	
BB36300	BN36300		300	3,5 ÷ 84	
BB36370	BN36370		370	3,5 ÷ 106	
BB48120	BN48120	4,8	120	3,5 ÷ 23,8	218
BB48160	BN48160		160	3,5 ÷ 36,6	
BB48180	BN48180		180	3,5 ÷ 43	
BB48200	BN48200		200	3,5 ÷ 49,5	
BB48250	BN48250		250	3,5 ÷ 65	
BB48290	BN48290		290	3,5 ÷ 78	
BB48370	BN48370		370	3,5 ÷ 100	
BB48430	BN48430		430	3,5 ÷ 122,5	
BB76150	BN76150		7,6	150	
BB76200	BN76200	200		8,5 ÷ 50,9	
BB76290	BN76290	290		8,5 ÷ 79	
BB76370	BN76370	370		8,5 ÷ 103,5	
BB76450	BN76450	450		8,5 ÷ 130,5	
BB76540	BN76540	540		8,5 ÷ 141,59	
BB88770	BN88770	8,8	770	8,5 ÷ 230	779
BB88920	BN88920		920	8,5 ÷ 280	
BB88122	BN88122		1220	78 ÷ 375,5	
BB12225	BN12225	12,5	225	8,5 ÷ 57	1200
BB12500	BN12500		500	8,5 ÷ 156	
BB12720	BN12720		720	8,5 ÷ 216	
BB12850	BN12850		850	8,5 ÷ 263	
BB12100	BN12100		1000	8,5 ÷ 315	

#### PLANO

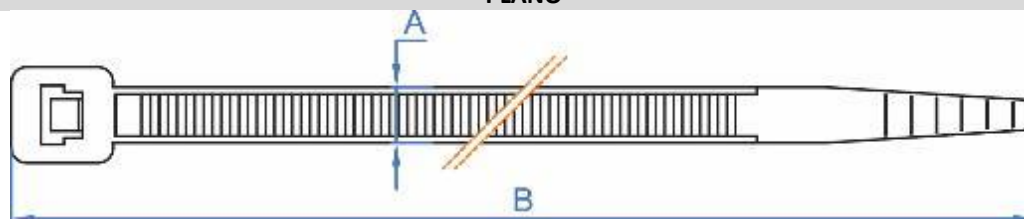

2.2

BN-VE/MA/AM/AZ/RO/GR

Bridas de nylon colores

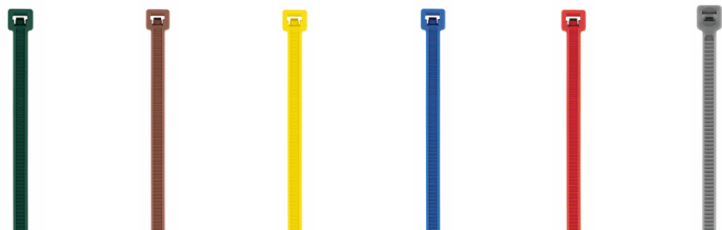

Características



Poliamida 6.6

Datos de Instalación

CODIGO	COLOR	A: Ancho [mm]	B: Largo [mm]	Resistencia a la tracción $\geq$ [N]
BC25100VE	VERDE	2,5	100	79
BC36140VE		3,6	140	178
BC36200VE			200	
BC48200VE		4,8	200	218
BC48290VE			290	
BC25100MA	MARRON	2,5	100	79
BC36140MA		3,6	140	178
BC36200MA			200	
BC48200MA		4,8	200	218
BC48290MA			290	
BC25100AM	AMARILO	2,5	100	79
BC36140AM		3,6	140	178
BC36200AM			200	
BC48200AM		4,8	200	218
BC48290AM			290	
BC25100AZ	AZUL	2,5	100	79
BC36140AZ		3,6	140	178
BC36200AZ			200	
BC48200AZ		4,8	200	218
BC48290AZ			290	
BC25100RO	ROJO	2,5	100	79
BC36140RO		3,6	140	178
BC36200RO			200	
BC48200RO		4,8	200	218
BC48290RO			290	
BC25100GR	GRIS (RAL7035)	2,5	100	79
BC36140GR		3,6	140	178
BC36200GR			200	
BC48200GR		4,8	200	218
BC48290GR			290	

PLANO

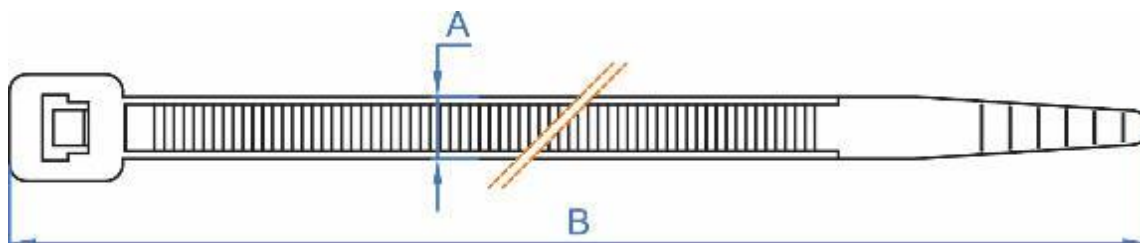

## 2.3 BN-DT

### Bridas de nylon detectable



#### Características



Poliamida 6.6

#### Datos de Instalación

CODIGO	COLOR	A: Ancho [mm]	B: Largo [mm]	Resistencia a la tracción $\geq$ [N]
BNDT25100	AZUL	2,5	100	80
BNDT36150		3,6	150	180
BNDT36200			200	
BNDT48200		4,8	200	230
BNDT48300			300	
BNDT48370			370	
BNDT76370		7,6	370	540

#### PLANO

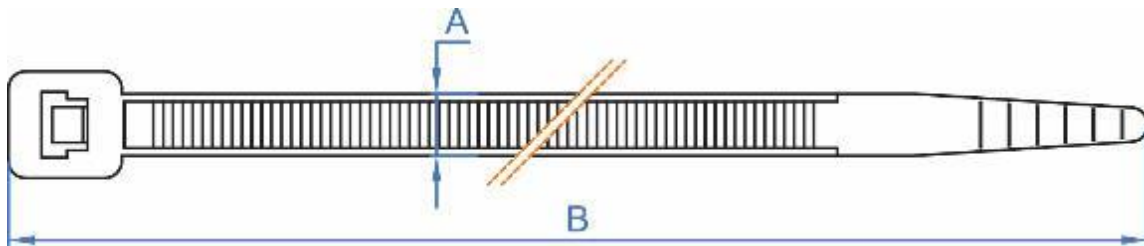

## 2.4 BN-ID

### Bridas de nylon con identificación



#### Características



Poliamida 6.6

#### Datos de Instalación

CODIGO	A: Ancho de brida [mm]	B: Largo de brida [mm]	C: Ancho de identificación [mm]	D: Largo de identificación [mm]	Tipo
BID25110	2,5	110	9,2	20,2	A
BID25210		210	8,1	25,1	B

#### PLANO

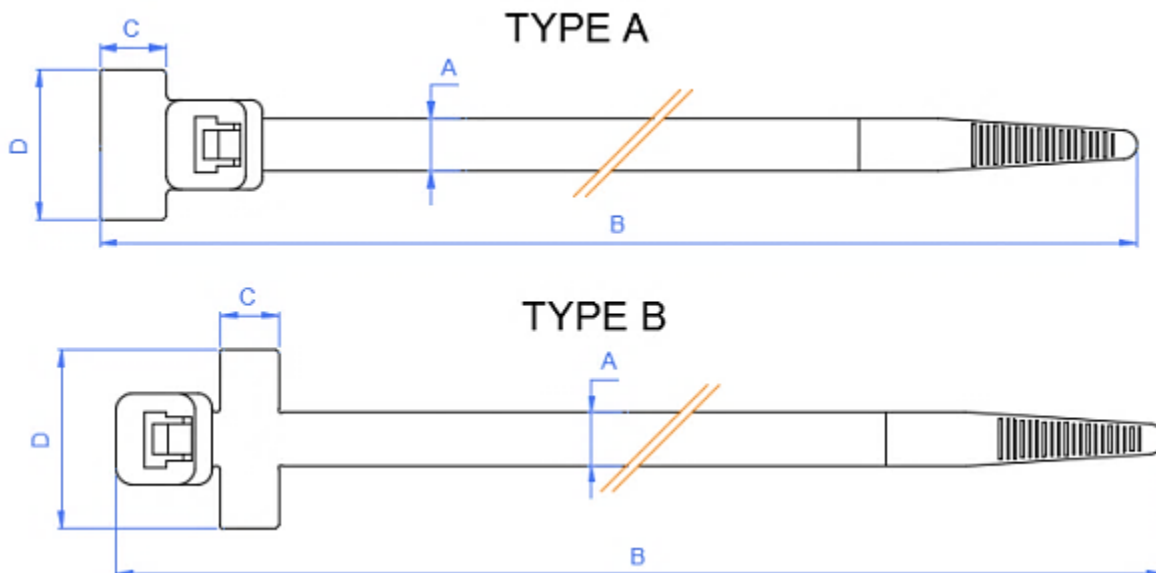

## 2.5 BN-BA

Base de dos vías adhesivas para bridas de nylon



Características



Poliamida 6.6

Datos de Instalación

CODIGO	Color	A: Ancho de base [mm]	B: Alto de base [mm]	C: Ancho máximo de brida ≤ [mm]	ØD: Diámetro del agujero [mm]	Tipo / Type
BBANA19	Blanco	19	5	4,8	6,8	A
BBANA27		27,5	5,25	5,2	5,8	B
BBANE19	Negro	19	5	4,8	6,8	A
BBANE27		27,5	5,25	5,2	5,8	B

PLANO

TYPE B

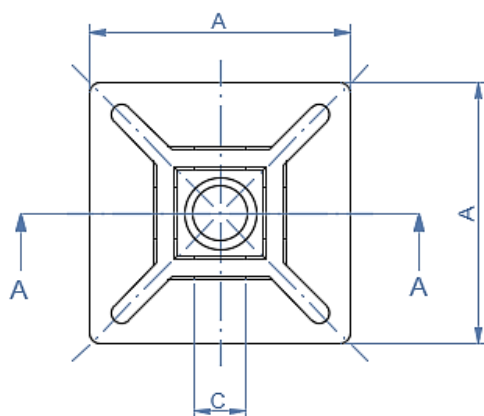

Sección A-A

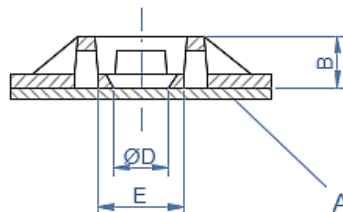

TYPE A

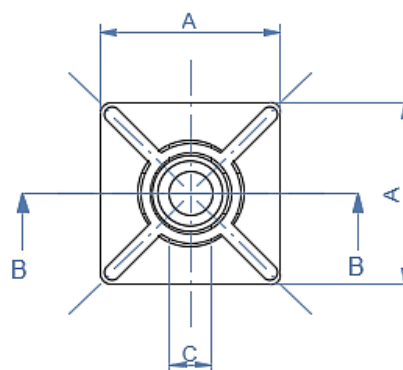

Sección B-B

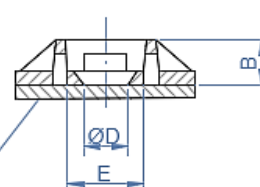

Adhesivo / Adhesive



## 2.6 BN-PL

### Placa de identificación de bridas de nylon

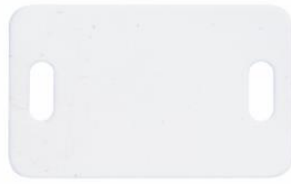

#### Características



Poliamida 6.6

#### Datos de Instalación

CODIGO	A [mm]	B [mm]	C [mm]	D [mm]	E [mm]	F [mm]
BPL02616	26,4	16,2	1	2	2	5

#### PLANO

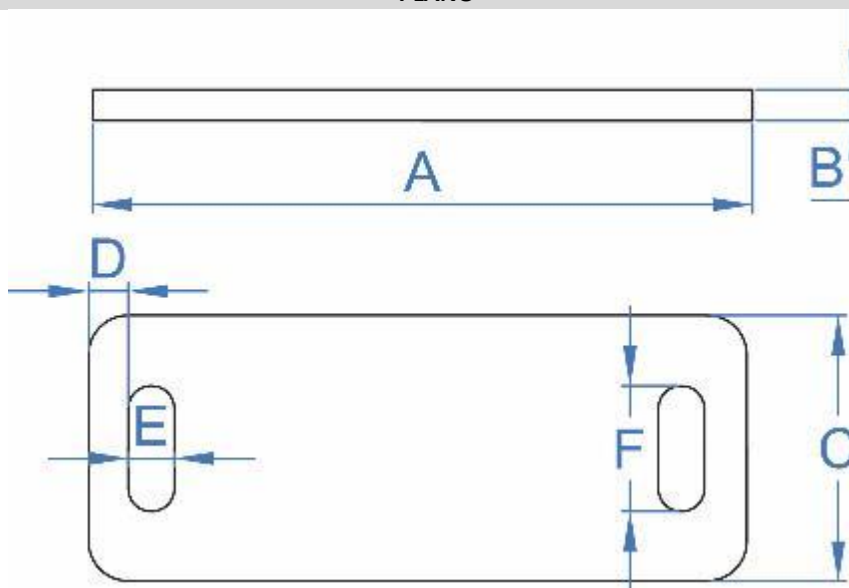

## 2.7 TACOBRI B/N/GR Taco para bridas de nylon



### Características



Poliamida 6.6

### Datos de Instalación

CODIGO	Color	Ø Diámetro de broca [mm]	Profundidad de taladro [mm]	A [mm]	B [mm]	C [mm]	D [mm]	E [mm]	L [mm]
TACOBRI6	Blanco	6	45	12,75	12,75	9,5	3	6	40
TACOBRI8		8							43.5
TACOBRI6	Negro	6							40
TACOBRI8		8							43.5
TACOBRI8		Gris							8

### PLANO

