

EQ-AC

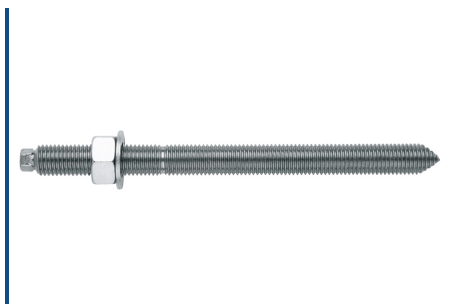

EQ-8.8

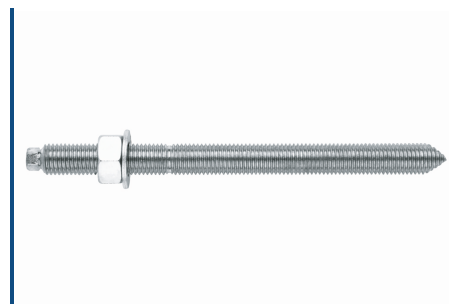

EQ-A2

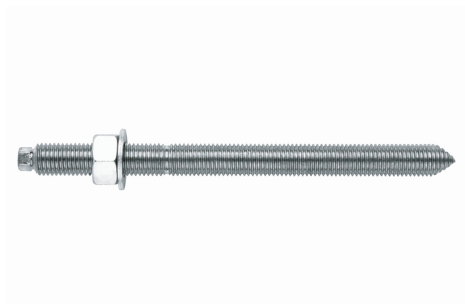

EQ-A4

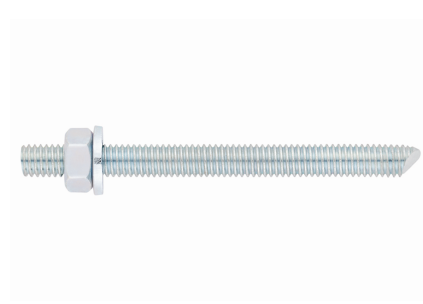

MO-ES

CARACTERISTICAS

- Espárragos con arandela y tuerca para aplicación de anclaje químico
- Empleo: instalación de barandillas, edificación de hormigón en construcción, estantería industrial, mobiliario urbano, obra civil...
- Variedad de métricas y longitudes disponibles
- Variedad de recubrimientos para aplicaciones interiores y exteriores
- Compatibles con toda la gama de productos de fijaciones químicas del catálogo de Index







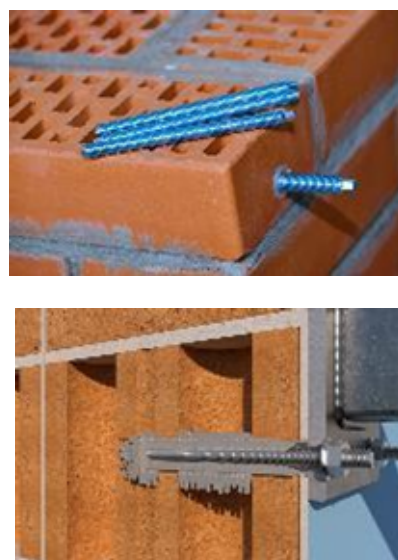





MATERIAL BASE

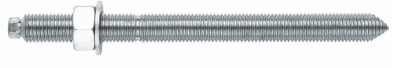

EJEMPLOS DE APLICACION

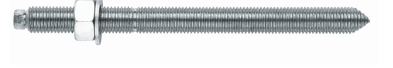

1. GAMA

ITEM	FOTO	REFERENCIA	DESCRIPCION	MATERIAL	RECUBRIMIENTO
1		EQAC08110	Espárragos acero roscado, Clase 5.8 ISO 898-1	 Acero	 Cincado $\geq 5\mu\text{m}$
		EQAC10130			
		EQAC10190			
		EQAC12160			
		EQAC12220			
		EQAC16190			
		EQAC16250			
		EQAC20260			
		EQAC20350			
		EQAC24300			
		EQAC24380			
EQAC30330					
2		EQ8808110	Espárragos acero roscado, Clase 8.8 ISO 898-1	 Acero	 Cincado $\geq 5\mu\text{m}$
		EQ8810130			
		EQ8812160			
		EQ8816190			
		EQ8820260			
EQ8824300					
3		EQA208110	Espárragos acero inoxidable A2-70	 Acero Inoxidable A2	-
		EQA210130			
		EQA212160			
		EQA216190			
		EQA220260			
EQA224300					
4		EQA408110	Espárragos acero inoxidable A4-70	 Acero Inoxidable A4	-
		EQA410130			
		EQA412160			
		EQA416190			
		EQA420260			
EQA424300					
5		MOES06070	Espárrago roscado cincado, Clase 5.8 ISO 898-1	 Acero	 Cincado $\geq 5\mu\text{m}$
		MOES08110			
		MOES10115			
		MOES12110			

2. DATOS DE INSTALACION

2.1 EQ-AC

Espárrago de acero roscado. Clase 5.8



Recubrimiento



Cincado $\geq 5\mu\text{m}$

Material



Acero

Datos de Instalación

Código	D	L	L1
	[mm]	[mm]	[mm]
EQAC08110	M8	110	80
EQAC10130	M10	130	90
EQAC10190	M10	190	..*
EQAC12160	M12	160	110
EQAC12220	M12	220	..*
EQAC16190	M16	190	125
EQAC16250	M16	250	..*
EQAC20260	M20	260	170
EQAC20350	M20	350	..*
EQAC24300	M24	300	210
EQAC24380	M24	380	..*
EQAC30330	M30	330	280

Plano

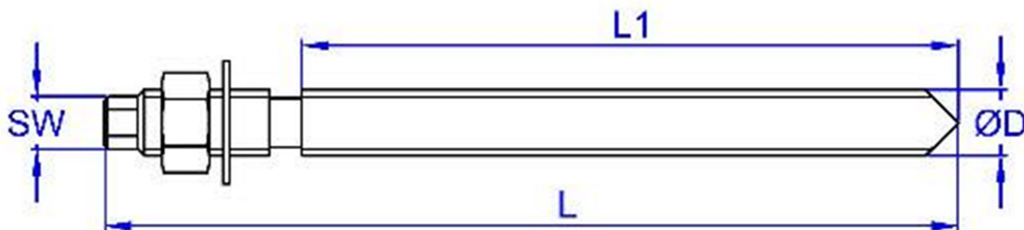

*Medida con rosca completa

2.2 EQ-8.8

Espárrago de acero roscado cincado. Clase 8.8



Recubrimiento



Cincado $\geq 5\mu\text{m}$

Material



Acero

Datos de Instalación

Código	D	L	L1
	[mm]	[mm]	[mm]
EQ8808110	M8	110	80
EQ8810130	M10	130	90
EQ8812160	M12	160	110
EQ8816190	M16	190	125
EQ8820260	M20	260	170
EQ8824300	M24	300	210

Plano

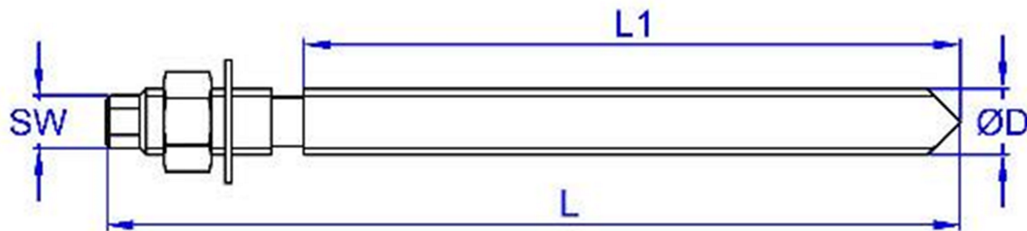

2.3 EQ-A2

Espárrago de acero inoxidable A2



Material



Acero Inoxidable A2

Datos de Instalación

Código	D	L	L1
	[mm]	[mm]	[mm]
EQA208110	M8	110	80
EQA210130	M10	130	90
EQA212160	M12	160	110
EQA216190	M16	190	125
EQA220260	M20	260	170
EQA224300	M24	300	210

Plano

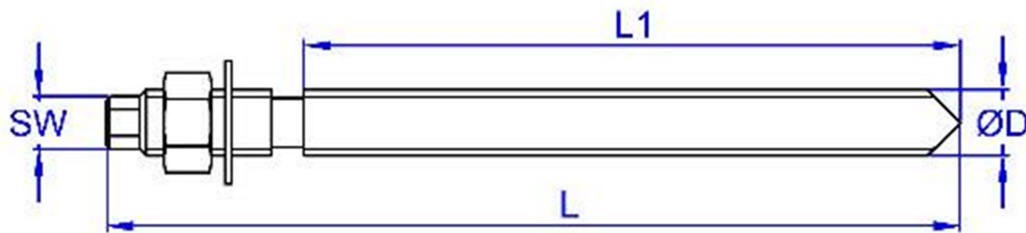

2.4 EQ-A4

Espárrago de acero inoxidable A4



Material



Acero Inoxidable A4

Datos de Instalación

Código	D	L	L1
	[mm]	[mm]	[mm]
EQA408110	M8	110	80
EQA410130	M10	130	90
EQA412160	M12	160	110
EQA416190	M16	190	125
EQA420260	M20	260	170
EQA424300	M24	300	210

Plano

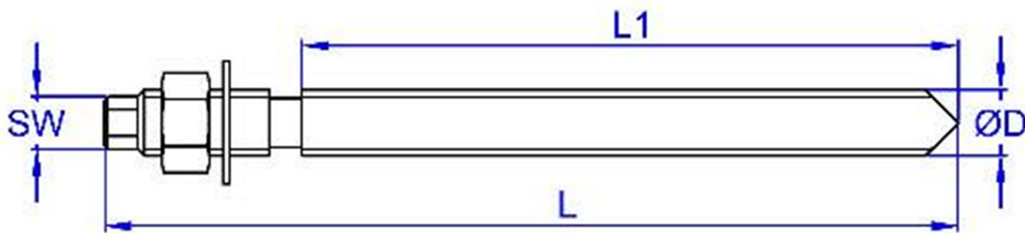

2.5 MO-ES

Espárrago roscado, cincado. Clase 5.8

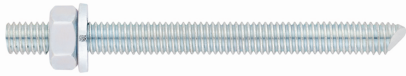

Recubrimiento



Cincado $\geq 5\mu\text{m}$

Material



Acero

Datos de Instalación

Código	D	L
	[mm]	[mm]
MOES06070	M6	70
MOES08110	M8	110
MOES10115	M10	115
MOES12110	M12	110

Plano

